

AS0821

推力轴承垫圈

舍弗勒ID：
0007888130000

技术信息

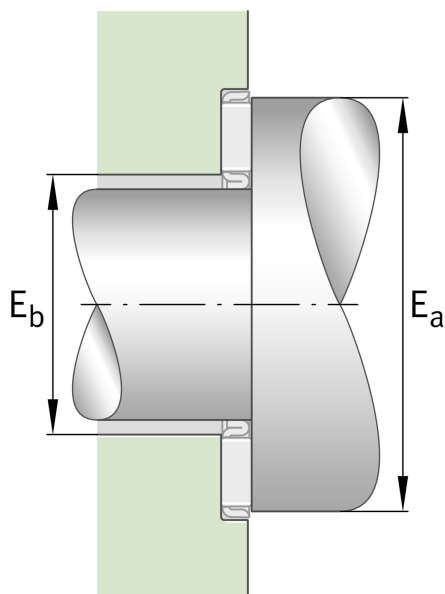
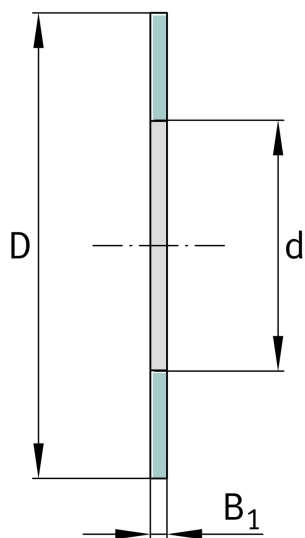

主要尺寸和性能数据

d	8 mm	Bore diameter bearing washer
D	21 mm	Outside diameter bearing washer
B ₁	1 mm	Hight bearing washer
	2.21 g	重量